

On/Off EZ Mount Dual Bank Control Battery Switch

772-DBC-EZ Mount Dual Bank Control (Retail Packed)

772-DBC-EZ-B (Bulk Packed)

Like 3 battery switches in one, House, Start and Emergency Parallel.

As easy to mount as 1, 2, 3, these revolutionary battery switches allow you to wire from the front. Never has installation been so easy and cabling so accessible.

With their shared interconnection height, EZ-Mount battery switches “cluster” directly with the Pro Installer Busbar Range, resulting in the fastest, most compact installations. All ratings and footprint of the EZ Mount Switch match those of the corresponding Pro Installer 770 series standard mount switch, offering the same high quality functionality, but with optimized, easy surface mounting.

1. Fit base
2. Add wiring
3. Clip on actuator

Features & Benefits:

- Easiest surface mounting, saves installation time and cost
- Front access studs match Pro Installer Busbar range interconnection height for direct linking and most mounting compact footprint
- Actuator assembly can be fitted at any angle for optimal cabling flexibility
- Removable knob for isolation/safety
- Includes back cover and three side panels for security and cable protection
- Designed to withstand harsh marine environments
- High temperature reinforced plastics

Installation Instructions: IMPORTANT! Read before installing

- It is recommended that electrical terminations and connections are carried out by a marine electrical technician.
- These battery switches are for isolation purposes and are not designed for switching under load. Ensure there are no circuits with high inductive loads directly connected to the switch in order to prevent any sudden in-rush of current which may cause damage to the switch.
- Although specially selected chemical resistant materials have been used, we recommend that for maximum product life only plastic safe corrosion inhibiting sprays are used.
- Ensure all cables are sized correctly for the loads they carry. Please refer to www.bepmarine.com to calculate correct cable sizes.
- Ensure all electrical connections are correctly tightened to prevent any damage to the battery switch.

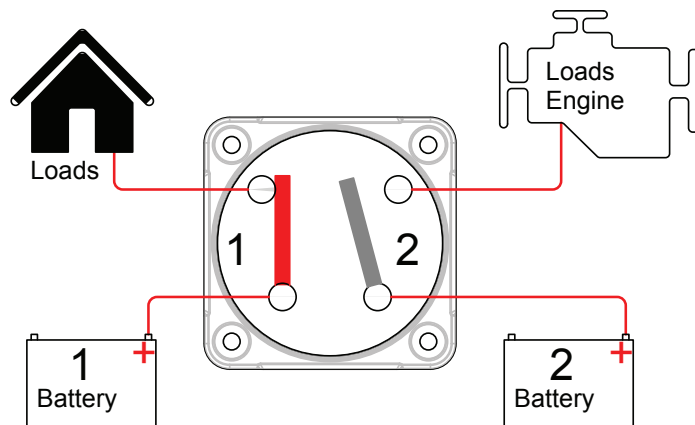
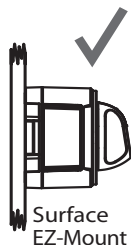

Dual Bank Control features unique “isolated ON” position, House on, Engine off. Patent pending.

Specifications:

- Continuous rating: 400A*
- Intermittent rating: 600A* (5min)
- Cranking rating: 1500A* (10sec)
- 12-48V DC
- Connection stud size: M10 (3/8")
- IP67 – short periods of immersion
- Ignition protected
- Independently tested to meet UL1107 standards
- CE marked

*Electrical ratings achieved using cable size 120mm²

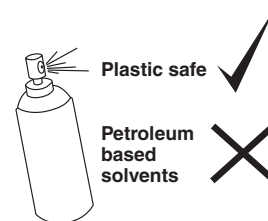

EZ Mount Installation (Surface Mount Only)

1. Disconnect battery positive leads at the batteries for safety
2. Choose mounting location on a flat surface close to the batteries
3. Select pan head (or similar) screws for mounting - use either M5 or 10g imperial (not included)
4. With Actuator removed, use the switch base as a mounting template to mark the hole positions. See details on next page for Actuator removal
5. Drill holes and screw switch base into position
6. Connect cables to studs ensuring that batteries and loads are correctly fitted
7. Ensure cables are secured to ISO/ABYC standards, and that cables are supported so they are not placing unnecessary strain on the battery switch studs
8. Check that spring washers are fitted beneath nuts
9. Tighten the stud nuts to 13.5 Nm (10 lbf)
10. Slot the side panel(s) into the Actuator as required
11. Replace Actuator, ensuring that both switch base and Actuator are both in their "OFF" positions
12. Lock the Actuator Grey fastening screws
13. With switch in "OFF" position connect battery positive leads at battery
14. Check switch operation

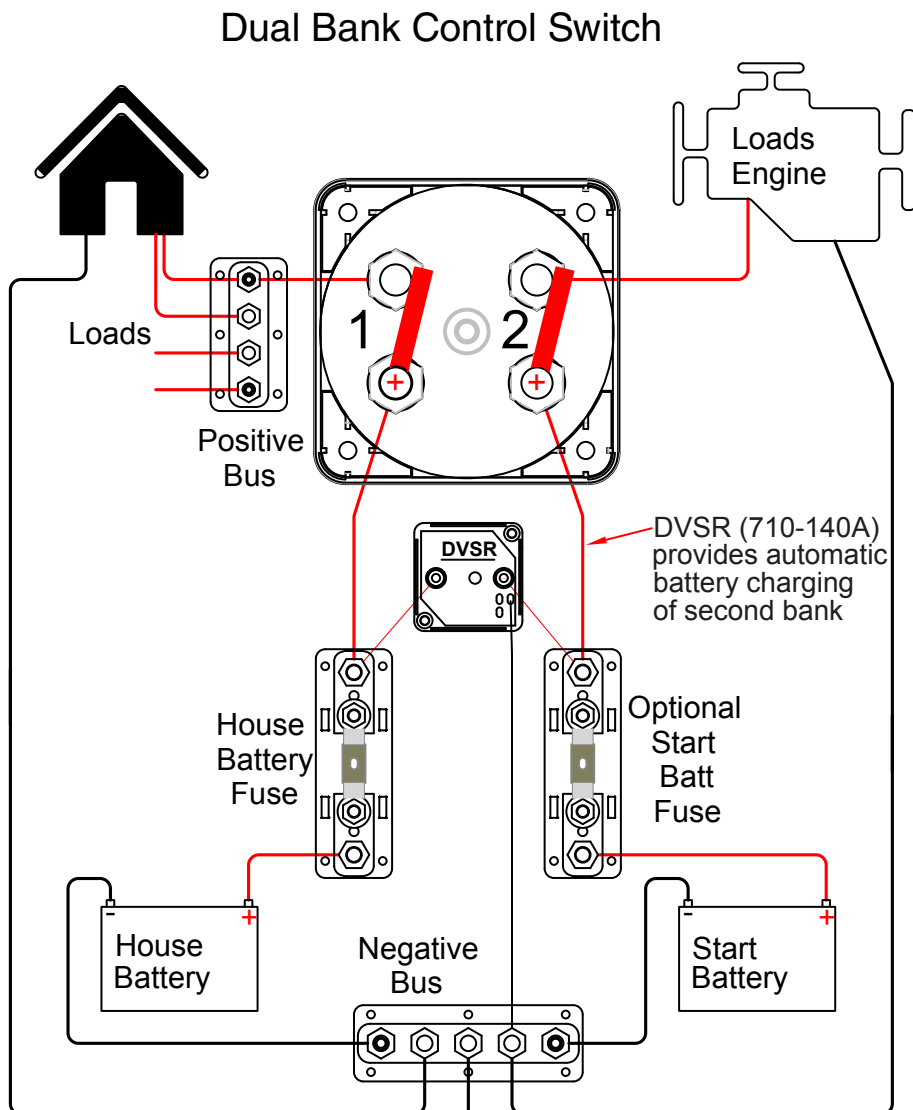
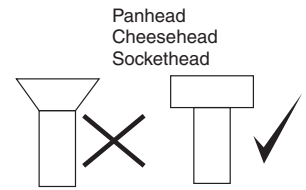

Example System:

NOTE -This diagram is a guide only showing Dual Bank Control Switch connections and is not intended as a full electrical systems wiring diagram.

Removal of Actuator (always remove, and replace the Actuator with knob in the "OFF" position):

1. Ensure knob is on "OFF" position
2. Undo light grey fastening screws by rotating 45 degrees anticlockwise
3. Remove Actuator

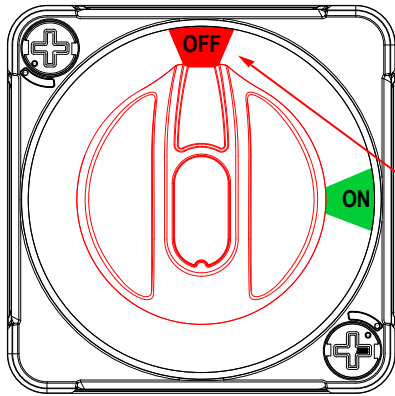
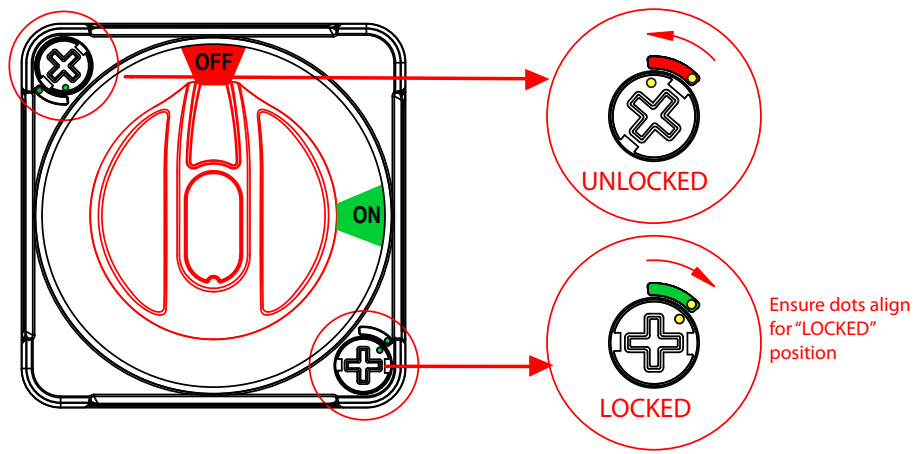

Always remove & replace Actuator with knob in the "OFF" position

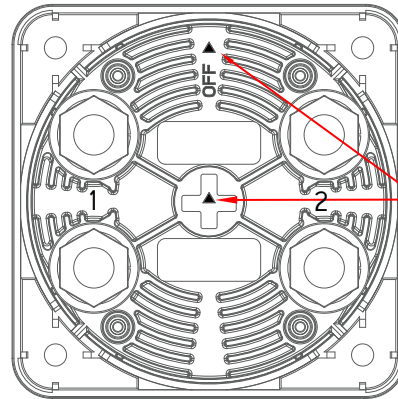

Off Position For Switch Base, When Arrows On Shaft Points At "OFF"

Replacement of Actuator (always remove, and replace the Actuator with knob in the "OFF" position)

1. Check that switch contact shaft (on base) hasn't been rotated, and that arrow on base shaft is pointing towards "OFF" engraving
2. Ensure that that light grey fastening screws are in the "unlocked" position
3. Ensure that Actuator knob is rotated to the "OFF" position
4. Note that Actuator can be fitted at any position 0/90/180/270 to suit electrical cabling
5. Replace Actuator

Fit Actuator at 0, 90, 180, or 270 degrees to suit cabling

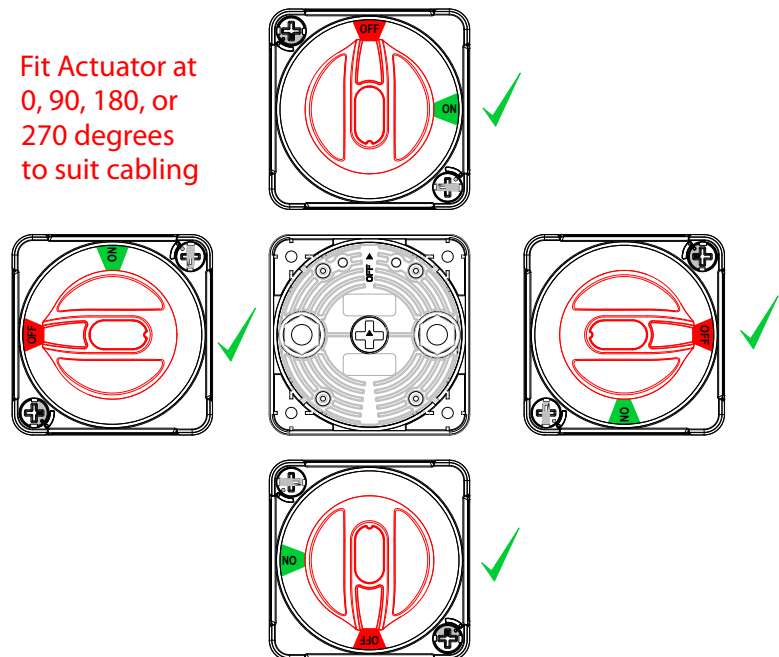

Check switch operation:

- a. Loads have no voltage in "OFF" position
- b. Loads have voltage in "ON" position
- c. House loads only have voltage in "1 ON" position

Dimensions (not to scale):

